

- (A) Colector drenaje 2"
2" Drainage manifold
- (B) Colector entrada 8"
8" Inlet manifold
- (C) Colector salida 8"
8" Outlet manifold

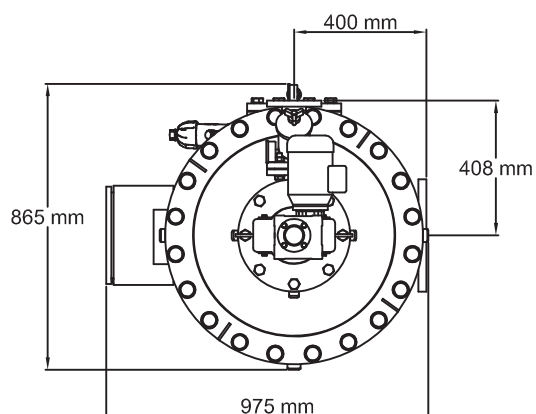

AZUD LUXON LDB 16500 S/8

SCALE S/E A4 FORMAT	MATERIAL:	RESPONS.: M. Martínez	AZUD
	UNITS: mm.	REVISION: 00	
	FILE: Azud_luxon_LDB_16500-S8.dwg	07/05/2012	