

- (A) Colector drenaje 2"  
**2" Drainage manifold**
- (B) Colector entrada 10"  
**10" Inlet manifold**
- (C) Colector salida 10"  
**10" Outlet manifold**

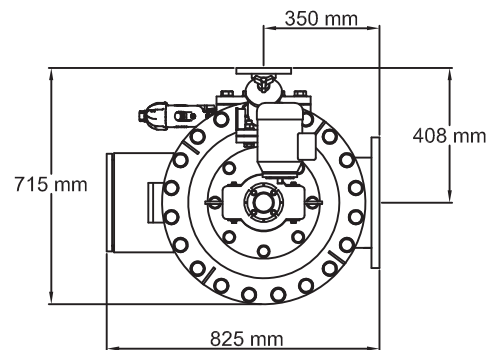

### AZUD LUXON LDB 13200 S/10

SCALE S/E A4 FORMAT	MATERIAL:	RESPONS.: M. Martínez	<b>AZUD</b>
	UNITS: mm.	REVISION: 00	
	FILE: Azud_luxon_LDB_13200-S10.dwg	07/05/2012	